

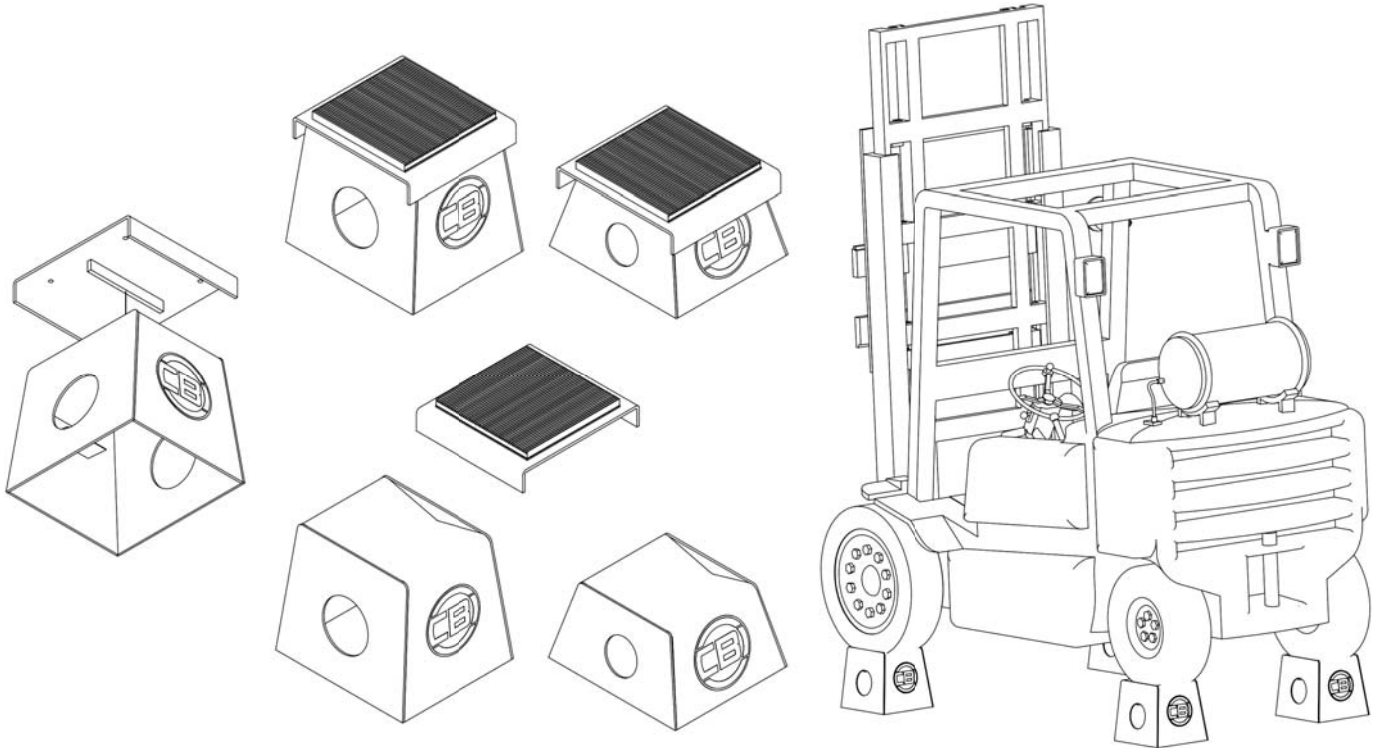

SAFETY ITEMS

SAFETY STANDS



OVERVIEW

CBI Safety Stands are safer than wood blocks and more stable than standard jack stands. The lightweight, stackable design is easy to handle and store.

FEATURES

- Use under tires, or under frame with optional cover cap
- Heavy duty all steel construction
- Cradle design prevents rolling
- Curbed edge for improved safety
- Space saving stackable design

SPECIFICATIONS

Part #	Description	Capacity
Safety Stands		
LTSS-7	6.5" High Stackable	10,000#
LTSS-10	10.5" High Stackable	10,000#
Parts and Accessories		
LTSS-10CR	Cover Caps for Stackable Stands	



CBI SAFETY STANDS

OPTIONS



CBI SAFETY STAND WITH
OPTIONAL STAND PLATFORM

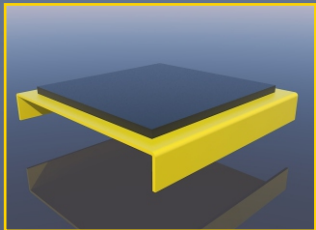

STEEL BASE WITH RIBBED
RUBBER SURFACE



USE UNDER FRAME
WITH STAND PLATFORM

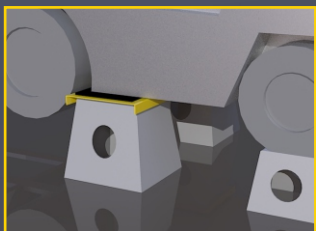

HEAVY DUTY ALL STEEL
CONSTRUCTION

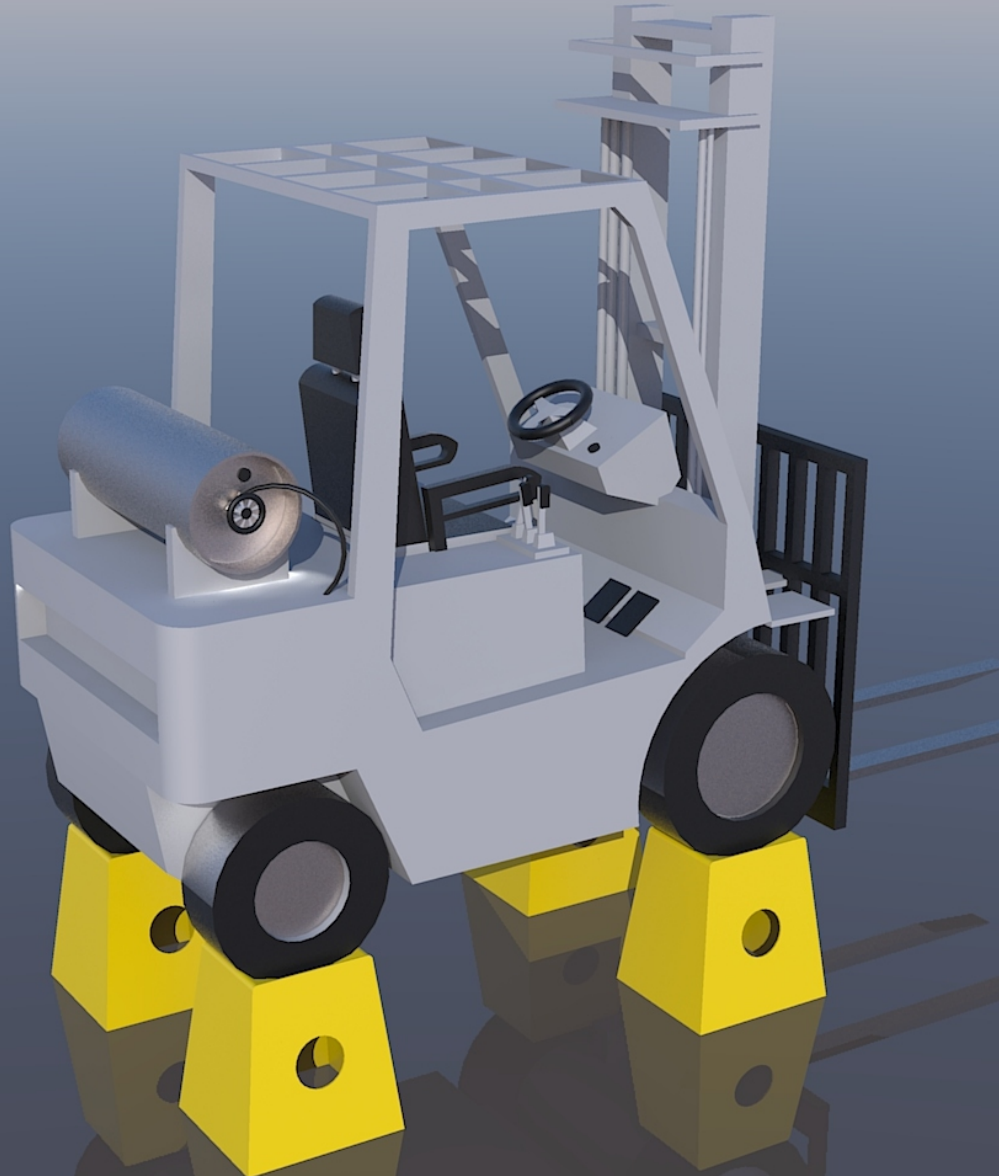

CBI Safety Stands are safer than wood blocks and more stable than standard jack stands. The lightweight, stackable design is easy to handle and store. 10,000 pound capacity each.

FEATURES

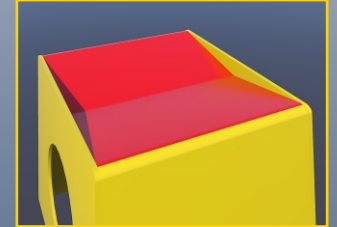

CRADLE DESIGN
PREVENTS ROLLING

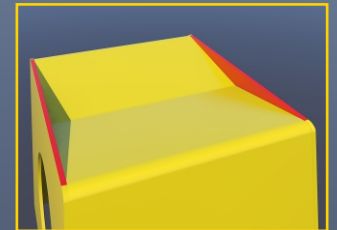

CURBED EDGE FOR
IMPROVED SAFETY

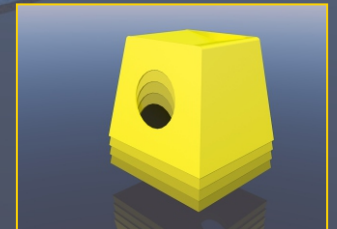

SPACE SAVING
STACKABLE DESIGN

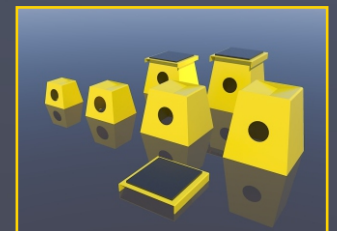

CUSTOM SIZES AND
CAPACITIES AVAILABLE